

Abgleich-Anweisung PK 58
ZF-Abgleich 460 kHz

Bereich Drehko-Stellung	Ankopplung des Meßsenders	Abgleich	Empfindlichkeit	Bemerkungen
MW, ausgedreht	G ₁ EBF 89	I und II Maximum	580 µV	Mit wechselseitiger Bedämpfung (10 kΩ und 5 nF in Reihe) abgleichen. ZF-Trennschärfe 1:100 ZF-Bandbreite 4,5 kHz ZF-Sicherheit bei 600kHz 1:325
	G ₁ ECH 81	III und IV Maximum	11 µV	
MW, eingedreht	an Antenne	V Minimum		Sperrtiefe 1:17
1 MHz	G ₁ ECH 81		14 µV	Mischempfindlichkeit

Oszillator- und Vorkreisabgleich

Frequenz Zeigerstellung	Oszillator	Vorkreis	Schwingstrom µA	Empfindlichkeit µV	Spiegelselektion	Bemerkungen
560 kHz	1 Maximum	* 2 Maximum	280 ... 350 ... 390	5	1:700 ... 1:420 ... 1:220	* Der Vorkreisabgleich erfolgt durch Verschieben der Spule auf dem Ferritstab.
1450 kHz	3 Maximum	4 Maximum				

NF-Empfindlichkeit (bei 400 Hz) an G₁ EL 95 : 445 mV
 an G₁ ECC 83' : 500 mV
 an G₁ ECC 83 : 6,3 mV

Abgleich-Anweisung TS 58
ZF-Abgleich 10,7 MHz

Meßsender-Modulation	Ankopplung des Meßsenders	Abgleich	Abgleichsanzeige	Empfindlichkeit µV	Bemerkungen
		AM-Unterdrückungs-trimmer R 112 (3 k)			Ist nur mit einem Abgleich-Oszillographen abzugleichen.
AM, FM oder unmoduliert	G ₁ EF 89 II	a Maximum	Röhrevoltmeter an C 117, Outputmeter bei FM	1900	Meßsender-Ausgangsspannung so wählen, daß während des Abgleichs ca. 2 V _{eff} am Ratio-Elko stehen. Outputmeter auf minimale NF-Amplitude
AM		b Minimum	Outputmeter und RV an C 117		
AM, FM oder unmoduliert	G ₁ EF 89 I	c Maximum d Maximum	Röhrevoltmeter an C 117	50	Meßsender-Ausgangsspannung so wählen, daß während des Abgleichs ca. 2 V _{eff} am Ratio-Elko stehen.
	Lose ins Mischteil einkoppeln.	e inneres Maximum f Maximum			

Oszillator-, Zwischen- und Antennenkreis-Abgleich

Meßsender-Frequenz Zeigerstellung	Oszillator	Zwischenkreis	Antennenkreis	Abgleich-Anzeige	Schwingspannung V	Empfindlichkeit (Rauschzahl)	Bemerkungen
88 MHz Kanal 4	A Maximum	B inneres Maximum	* D	Outputmeter bei FM-Sender (oder ohne Mod. mit RV an C 117).	2,8 ... 3	3 kTo	* Da der Kreis D sehr breit ist, wird der Kern 2,5 mm unter dem oberen Spulenkörper eingest. l.
99 MHz Kanal 40		C Maximum					

NF-Empfindlichkeit (bei 800 Hz) an G₁ EL 95 / EL 95 : 400 / 400 mV
 an G₁ ECC 83' : 450 mV
 an G₁ ECC 83 : 6,5 mV

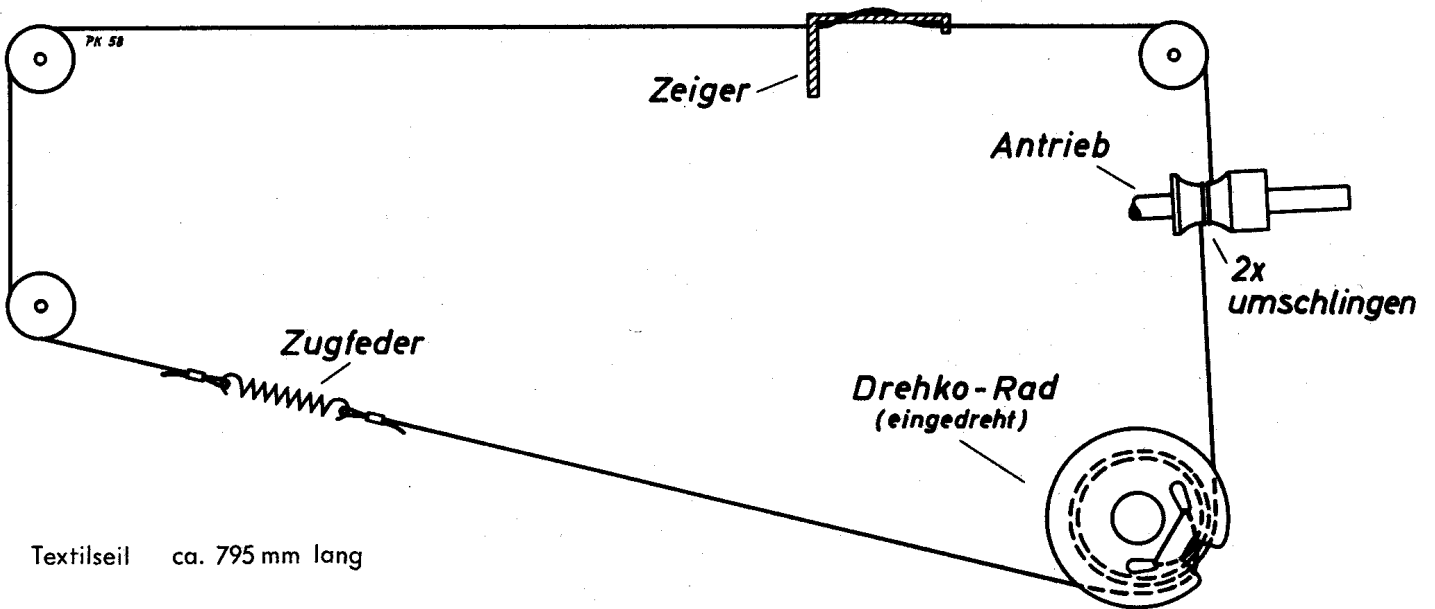

Schnurlaufführung TS 58 von der Lautsprecherseite gesehen

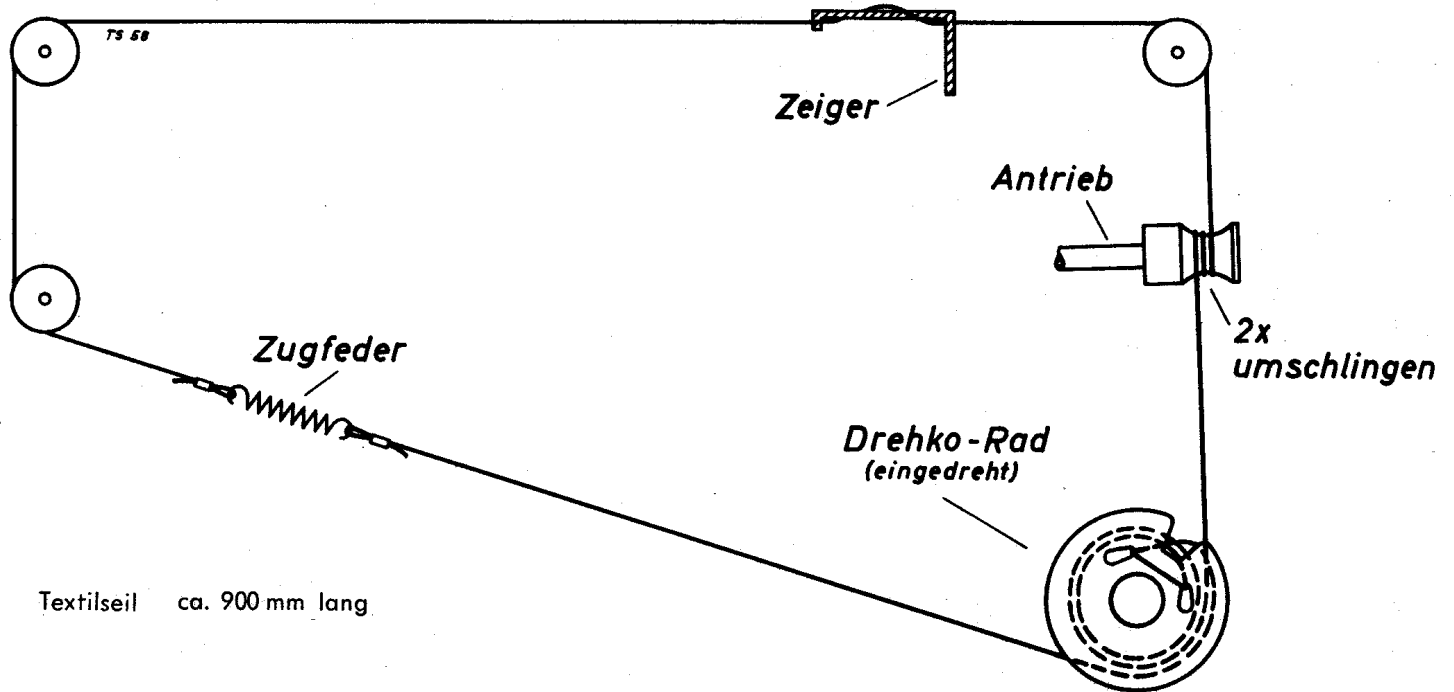

ECH 81

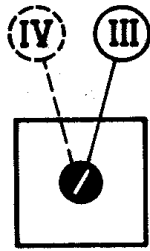
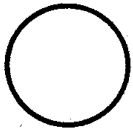

EBF 89

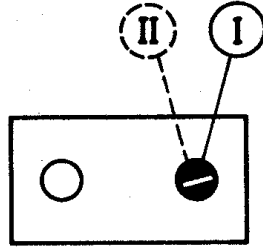
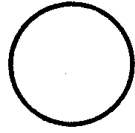

Y



4



1



2



3

Chassis-Ausschnitt PK 58
von unten gesehen

EF89I

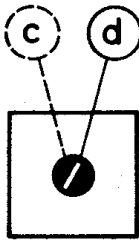
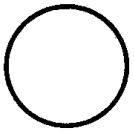

EF89II

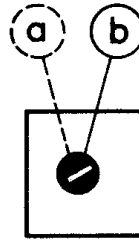
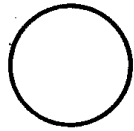

R112

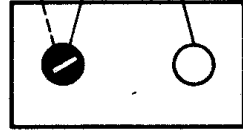

C

A

e

(X)



B

f



D

Chassis-Ausschnitt TS 58
von unten gesehen

Schaltplan für PK 58

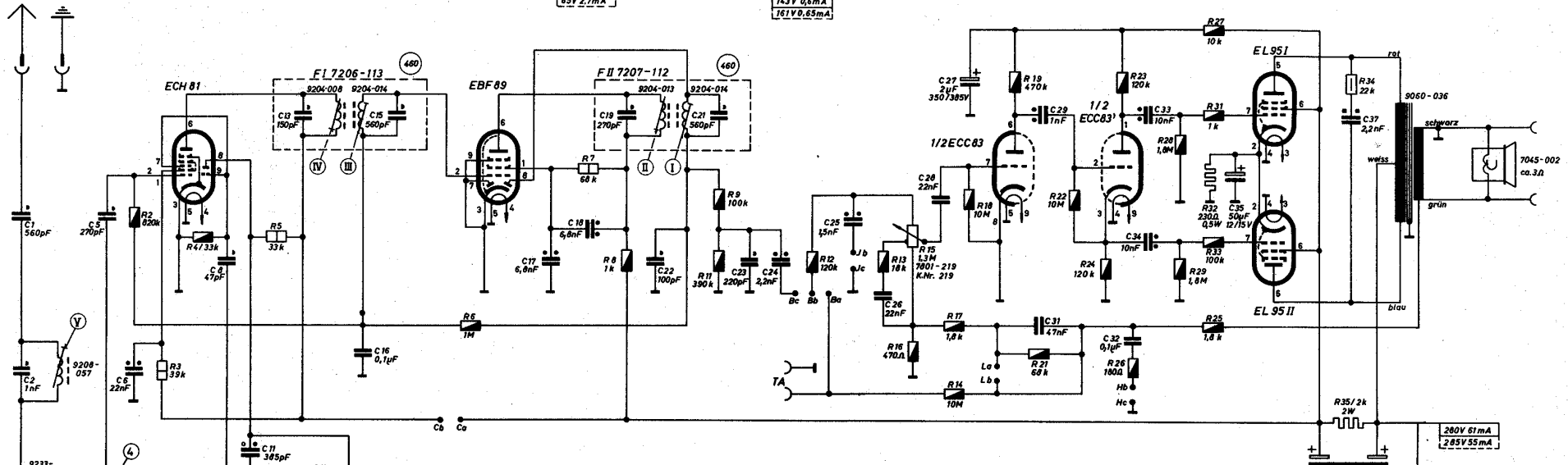
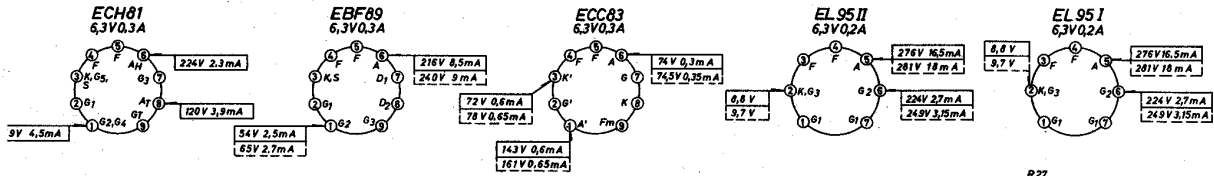

AM - Spulensatz: 7422-010 ZF=460 kHz
Wellenbereich: MW 510...1620 kHz

Spannungen mit GRUNDIG - Röhrevoltmeter gemessen. Meßwerte gelten bei MW TA ohne Signal an der Antenne.

ÄNDERUNGEN VORBEHALTEN

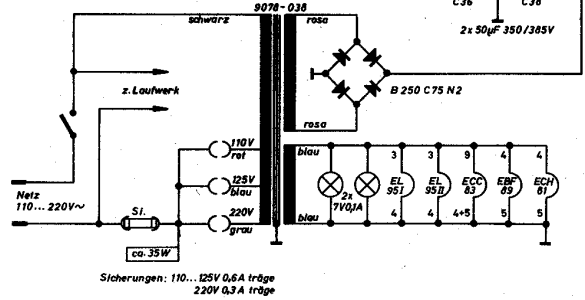
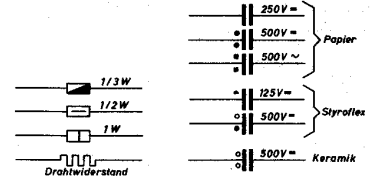
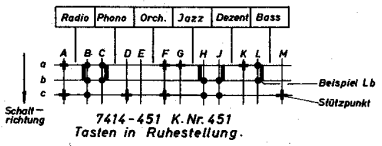

C:	1, 2, 3,	4, 5,	6, 7,	8,	9,	10, 11,	12, 13,	14, 15,	16,	17,	18,	19,	20,	21,	22,	23,	24,	25,	26,	27,	28,	29,	30,	31,	32,	33,	34,	35,	36,	37,	38,
R:	1,	2,	3,	4,	5,	6,	7,	8,	9, 11,	12,	13,	14, 15, 16,	17,	18,	19, 21,	22,	23, 24,	25,	26,	27,	28,	29,	30,	31,	32,	23, 26,	24, 25, 27, 31, 32, 33,	34,	35,	36, 37,	38,

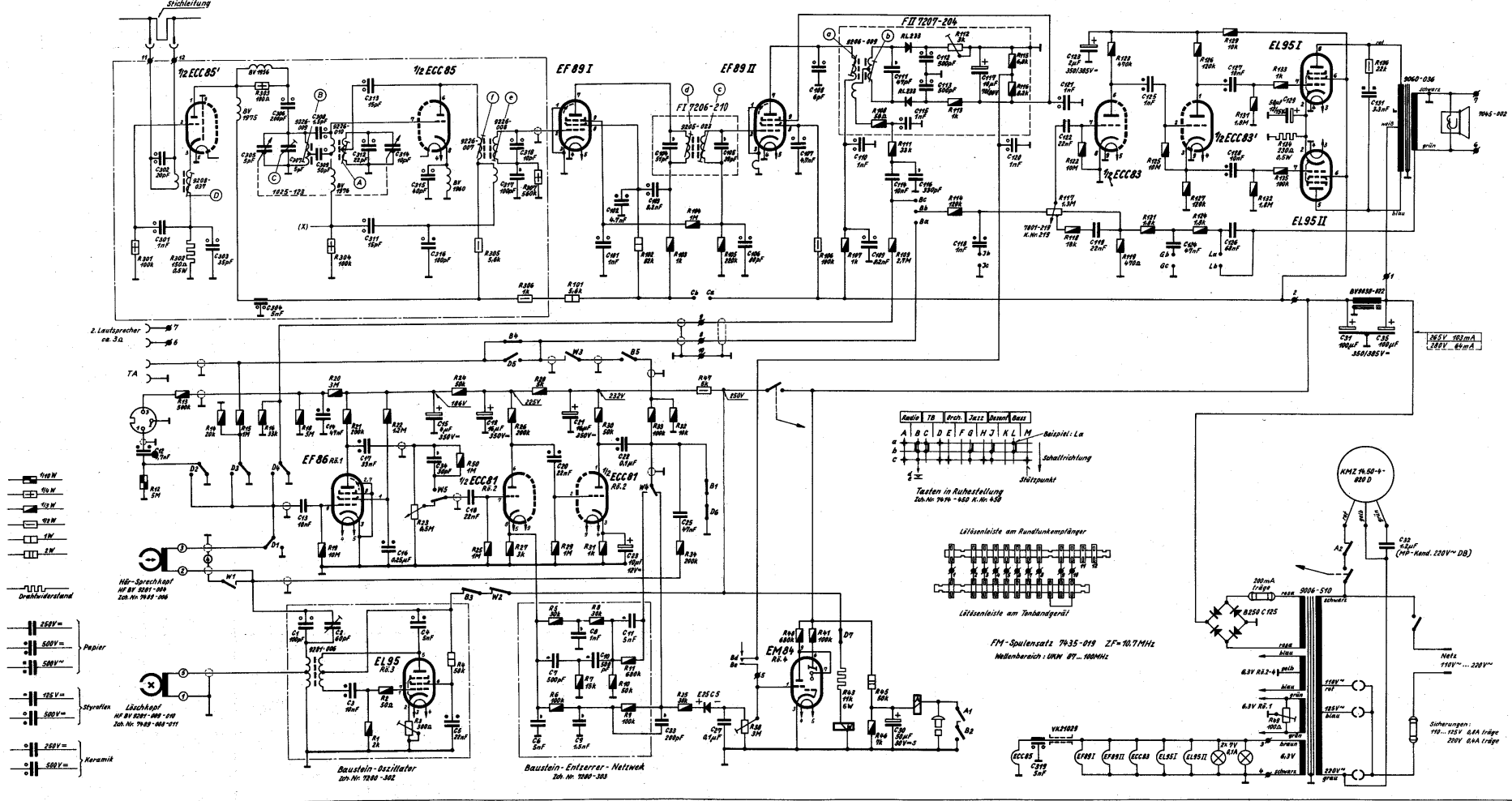
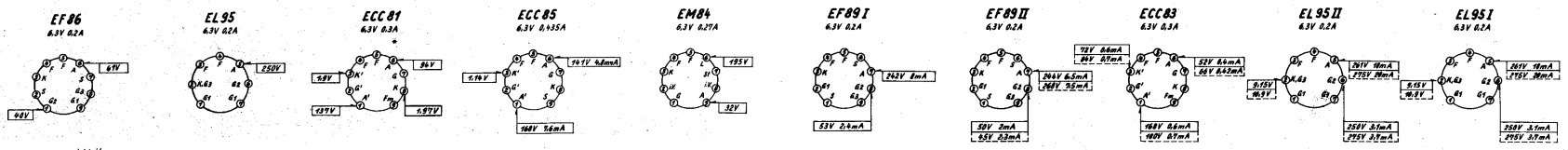

- 0.1µF
- 0.2µF
- 0.5µF
- 1µF
- 2µF
- 5µF
- 10µF
- 20µF
- 50µF
- 100µF
- 200µF
- 500µF
- 1000µF
- 10µF
- 20µF
- 50µF
- 100µF
- 200µF
- 500µF
- 1000µF

Rundfunk	C:	301, 302, 303, 305, 306, 308, 307, 308, 309, 310, 311, 313, 314, 315, 316, 317, 318, 319, 320, 321, 322, 323, 324, 325, 326, 327, 328, 329, 330, 331, 332, 333, 334, 335, 336, 337, 338, 339, 340, 341, 342, 343, 344, 345, 346, 347, 348, 349, 350, 351, 352, 353, 354, 355, 356, 357, 358, 359, 360, 361, 362, 363, 364, 365, 366, 367, 368, 369, 370, 371, 372, 373, 374, 375, 376, 377, 378, 379, 380, 381, 382, 383, 384, 385, 386, 387, 388, 389, 390, 391, 392, 393, 394, 395, 396, 397, 398, 399, 400, 401, 402, 403, 404, 405, 406, 407, 408, 409, 410, 411, 412, 413, 414, 415, 416, 417, 418, 419, 420, 421, 422, 423, 424, 425, 426, 427, 428, 429, 430, 431, 432, 433, 434, 435, 436, 437, 438, 439, 440, 441, 442, 443, 444, 445, 446, 447, 448, 449, 450, 451, 452, 453, 454, 455, 456, 457, 458, 459, 460, 461, 462, 463, 464, 465, 466, 467, 468, 469, 470, 471, 472, 473, 474, 475, 476, 477, 478, 479, 480, 481, 482, 483, 484, 485, 486, 487, 488, 489, 490, 491, 492, 493, 494, 495, 496, 497, 498, 499, 500, 501, 502, 503, 504, 505, 506, 507, 508, 509, 510, 511, 512, 513, 514, 515, 516, 517, 518, 519, 520, 521, 522, 523, 524, 525, 526, 527, 528, 529, 530, 531, 532, 533, 534, 535, 536, 537, 538, 539, 540, 541, 542, 543, 544, 545, 546, 547, 548, 549, 550, 551, 552, 553, 554, 555, 556, 557, 558, 559, 560, 561, 562, 563, 564, 565, 566, 567, 568, 569, 570, 571, 572, 573, 574, 575, 576, 577, 578, 579, 580, 581, 582, 583, 584, 585, 586, 587, 588, 589, 590, 591, 592, 593, 594, 595, 596, 597, 598, 599, 600, 601, 602, 603, 604, 605, 606, 607, 608, 609, 610, 611, 612, 613, 614, 615, 616, 617, 618, 619, 620, 621, 622, 623, 624, 625, 626, 627, 628, 629, 630, 631, 632, 633, 634, 635, 636, 637, 638, 639, 640, 641, 642, 643, 644, 645, 646, 647, 648, 649, 650, 651, 652, 653, 654, 655, 656, 657, 658, 659, 660, 661, 662, 663, 664, 665, 666, 667, 668, 669, 670, 671, 672, 673, 674, 675, 676, 677, 678, 679, 680, 681, 682, 683, 684, 685, 686, 687, 688, 689, 690, 691, 692, 693, 694, 695, 696, 697, 698, 699, 700, 701, 702, 703, 704, 705, 706, 707, 708, 709, 710, 711, 712, 713, 714, 715, 716, 717, 718, 719, 720, 721, 722, 723, 724, 725, 726, 727, 728, 729, 730, 731, 732, 733, 734, 735, 736, 737, 738, 739, 740, 741, 742, 743, 744, 745, 746, 747, 748, 749, 750, 751, 752, 753, 754, 755, 756, 757, 758, 759, 760, 761, 762, 763, 764, 765, 766, 767, 768, 769, 770, 771, 772, 773, 774, 775, 776, 777, 778, 779, 780, 781, 782, 783, 784, 785, 786, 787, 788, 789, 790, 791, 792, 793, 794, 795, 796, 797, 798, 799, 800, 801, 802, 803, 804, 805, 806, 807, 808, 809, 810, 811, 812, 813, 814, 815, 816, 817, 818, 819, 820, 821, 822, 823, 824, 825, 826, 827, 828, 829, 830, 831, 832, 833, 834, 835, 836, 837, 838, 839, 840, 841, 842, 843, 844, 845, 846, 847, 848, 849, 850, 851, 852, 853, 854, 855, 856, 857, 858, 859, 860, 861, 862, 863, 864, 865, 866, 867, 868, 869, 870, 871, 872, 873, 874, 875, 876, 877, 878, 879, 880, 881, 882, 883, 884, 885, 886, 887, 888, 889, 890, 891, 892, 893, 894, 895, 896, 897, 898, 899, 900, 901, 902, 903, 904, 905, 906, 907, 908, 909, 910, 911, 912, 913, 914, 915, 916, 917, 918, 919, 920, 921, 922, 923, 924, 925, 926, 927, 928, 929, 930, 931, 932, 933, 934, 935, 936, 937, 938, 939, 940, 941, 942, 943, 944, 945, 946, 947, 948, 949, 950, 951, 952, 953, 954, 955, 956, 957, 958, 959, 960, 961, 962, 963, 964, 965, 966, 967, 968, 969, 970, 971, 972, 973, 974, 975, 976, 977, 978, 979, 980, 981, 982, 983, 984, 985, 986, 987, 988, 989, 990, 991, 992, 993, 994, 995, 996, 997, 998, 999, 1000
Tonband	C:	92, 93, 94, 95, 96, 97, 98, 99, 100, 101, 102, 103, 104, 105, 106, 107, 108, 109, 110, 111, 112, 113, 114, 115, 116, 117, 118, 119, 120, 121, 122, 123, 124, 125, 126, 127, 128, 129, 130, 131, 132, 133, 134, 135, 136, 137, 138, 139, 140, 141, 142, 143, 144, 145, 146, 147, 148, 149, 150, 151, 152, 153, 154, 155, 156, 157, 158, 159, 160, 161, 162, 163, 164, 165, 166, 167, 168, 169, 170, 171, 172, 173, 174, 175, 176, 177, 178, 179, 180, 181, 182, 183, 184, 185, 186, 187, 188, 189, 190, 191, 192, 193, 194, 195, 196, 197, 198, 199, 200, 201, 202, 203, 204, 205, 206, 207, 208, 209, 210, 211, 212, 213, 214, 215, 216, 217, 218, 219, 220, 221, 222, 223, 224, 225, 226, 227, 228, 229, 230, 231, 232, 233, 234, 235, 236, 237, 238, 239, 240, 241, 242, 243, 244, 245, 246, 247, 248, 249, 250, 251, 252, 253, 254, 255, 256, 257, 258, 259, 260, 261, 262, 263, 264, 265, 266, 267, 268, 269, 270, 271, 272, 273, 274, 275, 276, 277, 278, 279, 280, 281, 282, 283, 284, 285, 286, 287, 288, 289, 290, 291, 292, 293, 294, 295, 296, 297, 298, 299, 300, 301, 302, 303, 304, 305, 306, 307, 308, 309, 310, 311, 312, 313, 314, 315, 316, 317, 318, 319, 320, 321, 322, 323, 324, 325, 326, 327, 328, 329, 330, 331, 332, 333, 334, 335, 336, 337, 338, 339, 340, 341, 342, 343, 344, 345, 346, 347, 348, 349, 350, 351, 352, 353, 354, 355, 356, 357, 358, 359, 360, 361, 362, 363, 364, 365, 366, 367, 368, 369, 370, 371, 372, 373, 374, 375, 376, 377, 378, 379, 380, 381, 382, 383, 384, 385, 386, 387, 388, 389, 390, 391, 392, 393, 394, 395, 396, 397, 398, 399, 400, 401, 402, 403, 404, 405, 406, 407, 408, 409, 410, 411, 412, 413, 414, 415, 416, 417, 418, 419, 420, 421, 422, 423, 424, 425, 426, 427, 428, 429, 430, 431, 432, 433, 434, 435, 436, 437, 438, 439, 440, 441, 442, 443, 444, 445, 446, 447, 448, 449, 450, 451, 452, 453, 454, 455, 456, 457, 458, 459, 460, 461, 462, 463, 464, 465, 466, 467, 468, 469, 470, 471, 472, 473, 474, 475, 476, 477, 478, 479, 480, 481, 482, 483, 484, 485, 486, 487, 488, 489, 490, 491, 492, 493, 494, 495, 496, 497, 498, 499, 500, 501, 502, 503, 504, 505, 506, 507, 508, 509, 510, 511, 512, 513, 514, 515, 516, 517, 518, 519, 520, 521, 522, 523, 524, 525, 526, 527, 528, 529, 530, 531, 532, 533, 534, 535, 536, 537, 538, 539, 540, 541, 542, 543, 544, 545, 546, 547, 548, 549, 550, 551, 552, 553, 554, 555, 556, 557, 558, 559, 560, 561, 562, 563, 564, 565, 566, 567, 568, 569, 570, 571, 572, 573, 574, 575, 576, 577, 578, 579, 580, 581, 582, 583, 584, 585, 586, 587, 588, 589, 590, 591, 592, 593, 594, 595, 596, 597, 598, 599, 600, 601, 602, 603, 604, 605, 606, 607, 608, 609, 610, 611, 612, 613, 614, 615, 616, 617, 618, 619, 620, 621, 622, 623, 624, 625, 626, 627, 628, 629, 630, 631, 632, 633, 634, 635, 636, 637, 638, 639, 640, 641, 642, 643, 644, 645, 646, 647, 648, 649, 650, 651, 652, 653, 654, 655, 656, 657, 658, 659, 660, 661, 662, 663, 664, 665, 666, 667, 668, 669, 670, 671, 672, 673, 674, 675, 676, 677, 678, 679, 680, 681, 682, 683, 684, 685, 686, 687, 688, 689, 690, 691, 692, 693, 694, 695, 696, 697, 698, 699, 700, 701, 702, 703, 704, 705, 706, 707, 708, 709, 710, 711, 712, 713, 714, 715, 716, 717, 718, 719, 720, 721, 722, 723, 724, 725, 726, 727, 728, 729, 730, 731, 732, 733, 734, 735, 736, 737, 738, 739, 740, 741, 742, 743, 744, 745, 746, 747, 748, 749, 750, 751, 752, 753, 754, 755, 756, 757, 758, 759, 760, 761, 762, 763, 764, 765, 766, 767, 768, 769, 770, 771, 772, 773, 774, 775, 776, 777, 778, 779, 780, 781, 782, 783, 784, 785, 786, 787, 788, 789, 790, 791, 792, 793, 794, 795, 796, 797, 798, 799, 800, 801, 802, 803, 804, 805, 806, 807, 808, 809, 810, 811, 812, 813, 814, 815, 816, 817, 818, 819, 820, 821, 822, 823, 824, 825, 826, 827, 828, 829, 830, 831, 832, 833, 834, 835, 836, 837, 838, 839, 840, 841, 842, 843, 844, 845, 846, 847, 848, 849, 850, 851, 852, 853, 854, 855, 856, 857, 858, 859, 860, 861, 862, 863, 864, 865, 866, 867, 868, 869, 870, 871, 872, 873, 874, 875, 876, 877, 878, 879, 880, 881, 882, 883, 884, 885, 886, 887, 888, 889, 890, 891, 892, 893, 894, 895, 896, 897, 898, 899, 900, 901, 902, 903, 904, 905, 906, 907, 908, 909, 910, 911, 912, 913, 914, 915, 916, 917, 918, 919, 920, 921, 922, 923, 924, 925, 926, 927, 928, 929, 930, 931, 932, 933, 934, 935, 936, 937, 938, 939, 940, 941, 942, 943, 944, 945, 946, 947, 948, 949, 950, 951, 952, 953, 954, 955, 956, 957, 958, 959, 960, 961, 962, 963, 964, 965, 966, 967, 968, 969, 970, 971, 972, 973, 974, 975, 976, 977, 978, 979, 980, 981, 982, 983, 984, 985, 986, 987, 988, 989, 990, 991, 992, 993, 994, 995, 996, 997, 998, 999, 1000

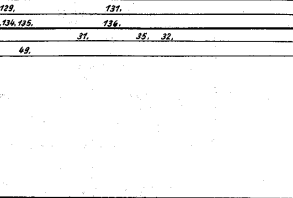
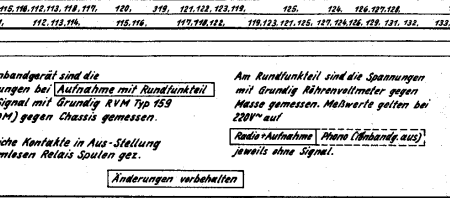
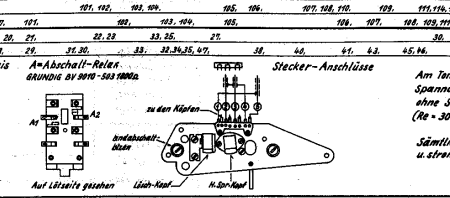
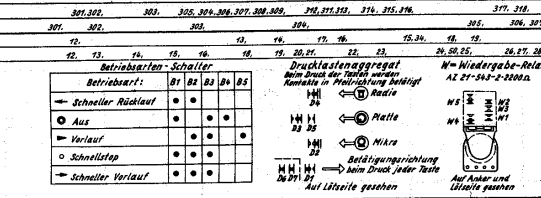

Betriebsarten-Schalter	B1	B2	B3	B4	B5
Schneller Rücklauf					
Aus					
Verlauf					
Schnellstop					
Schneller Verlauf					



Am Tonbandgerät sind die Spannungen bei Aufnahme mit Rundfunkteil ohne Signal mit Grundrig RVN Typ 153 (Re-30M) gegen Chassis gemessen.

Sämtliche Kontakte in Aus-Stellung u. stremlen Relais Spulen gez.

Änderungen vorbehalten

Am Rundfunkteil sind die Spannungen mit Grundrig Röhrenvoltmeter gegen Masse gemessen. Maßwerte gelten bei 220V auf

Röhre-Aufnahme (Phono-Einbandig aus) jeweils ohne Signal.